

EN

Water cooler
Installation, use and maintenance handbook

jclass

30 / 45

Cosmetal Installation Guidance

Caution: If the chiller has been lying down or upside down, leave it upright for at least 4 hours before use.

The below instructions are provided for summary guidance purposes for more detailed information please refer to the manual provided with the unit or download from our website.

1. **Select a suitable installation site:** Power within 1 metre, Potable water supply, Flat surface, Drainage in case of the Niagara FS or recessed drip trays, allow space around the cooler for ventilation – IN (Under counter) Models will require ventilation in the cupboard. Ensure you have a minimum of 2 bar water pressure and regulate the mains pressure with the pressure reducing valve to 3 bar.
2. **Connect the plumbing rail (PFRAILKITCOS)** to the mains, follow instructions provided with the kit. If using another kit, ensure you have the correct adapters and tubing before attempting installation. Cosmetal use 8mm fittings (equivalent to 5/16" imperial) on the inlet and 6mm fittings between the IN (under sink) units and the taps. Cosmetal supply the appropriate fittings as above with some 6mm and 8mm tubing. The PFRAILKITCOS plumbing rail has 8mm connections and a Fibredyne filter candle, both of which optimise the flow rate and chlorine removal capacity. Using a PFRAILKIT with Carbon Block Candle, or a PFRAILKITNANO with NANOF Candle requires ¼" diameter pipes. You will need an adapter at the Cosmetal unit's inlet to convert the ¼" to 8mm. The combination of the narrower ¼" pipe and the Carbon Block Candle can affect the flow rate adversely. To mitigate against that you can.
 - Change the Carbon Block Candle for an NANOF Candle which offers higher flow rates and a low pressure drop.
 - Reduce any ¼" pipe length should be as short as possible.
 - Open up the Pressure Regulator to increase the flow if on a low-pressure site.

We recommend you install a **scale removal filter with the Prostream boiler system** in hard water areas. We can supply the Brita C150 filter to facilitate this.

3. **To fill the ice bank;** refer to the manual for the different methods. Connect the pipe to the ice bank inlet and fill. Most models have a **visual indicator tube** on the back of the unit to identify the correct fill level. This tube can also be used to drain the ice bank before moving or relocation. Fill the ice bank to the max level. The Niagara free standing system does not have a visual indicator tube. Connect the drainage hose supplied at the back and drain into a bucket. Connect the incoming water to the ice bank inlet and fill the ice bank until the water runs from the drainage hose. To drain the Niagara ice bank you need to syphon or pump the water out.

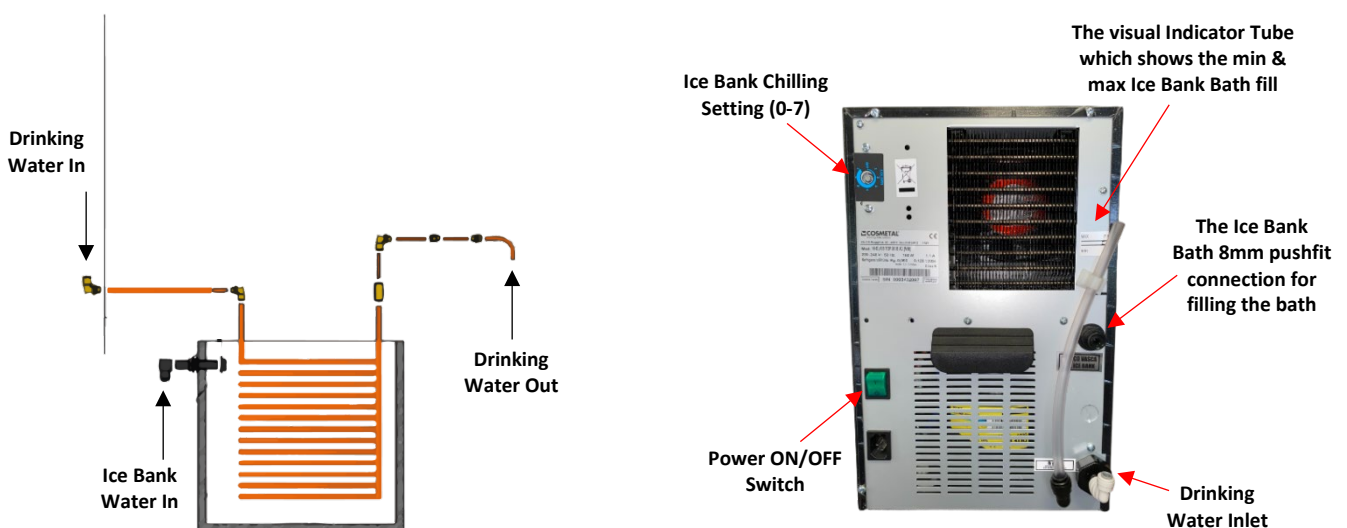

4. **Connect the inlet water supply:**

Disconnect incoming water feed from the ice bank and connect into the 8mm-5/16" water inlet fitting, located on the back of the cooler. Note some models have a 3/4" male BSP fitting, use the parts provide to adapt to 8mm.

5. **Turn the water and power on** and dispense water through all taps. Check for any leaks.

6. **With Gas versions,** connect the CO2 bottle to the CO2 Inlet. The recommended gas pressure should be no greater than 4 bar. Please note the CO2 pressure should be greater than the water pressure. Only turn the gas on after the tank has been filled (see step 5)

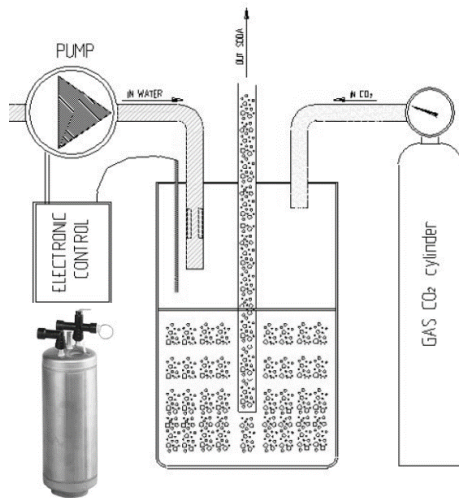

7. **Set the thermostat** we recommend you set the stat to 5 on the mechanical stats. (all models excluding the electronic control versions) Turn the stat clockwise to 5. Do not set to 7 as this could freeze the Ice bank.



8. **Set the thermostat on EC versions.** Thermostat settings need to be adjusted through the control panel. The default settings are -2 C for the summer months and +2 C for the winter. We recommend you set both to +2C. Please see the instruction manual for programming instructions. Failure to set the thermostat correctly could lead to a frozen ice bank.



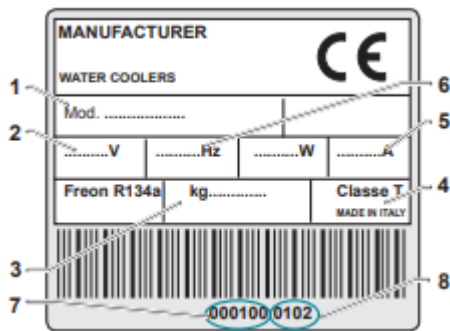

APPLIANCE DATA PLATE

- | | |
|---|-------------------------|
| 1 | Model |
| 2 | Supply voltage |
| 3 | Quantity of cooling gas |
| 4 | Class |
| 5 | Total absorption |
| 6 | Frequency |
| 7 | Serial number |
| 8 | Construction year-month |

EN CONFORMANCE STATEMENT

This appliance has been manufactured with suitable materials for use with drinking water. The device conforms to L.D. 108 dated 25.01.1992. The appliance has been approved by the 

This product was designed, made and put on the market respecting the following conformities:

- Following EC requirements safety objectives of the 2014/35 UE/LVD;
- Protection requisites of 2014/30/UE EMC.

EN 1 BEFORE USING THE APPLIANCE

1.1 WARNINGS



In order to use your appliance to its best, we advise reading these instructions carefully as they contain useful information.

- Keep this book for later use.
- When you have removed the packaging, make sure that the appliance is not damaged. Any damage must be reported to your carrier within 24 hours.



If the machine has been put down or turned upside down, wait for at least 8 hours before putting it into operation

- Make sure that installation and electrical wiring are carried out by a qualified technician according to the manufacturer's instructions and to the local norms in force. The electrical system must be equipped with an effective earth according to the law (46/90).

1.2 GENERAL PRECAUTIONS AND SUGGESTIONS



Before carrying out any maintenance or cleaning operation, remove the plug from the mains socket.

- Do not pull on the supply cable in order to remove the plug from the socket.
- When the appliance has been installed, make sure it is not resting on the mains supply cable.



The manufacturer reserves the right to change the product and its instructions manual without prior notice or updating of previous productions



Failure to comply with any of these safety regulations could cause fires, electric shocks or damage the machine

Place of installation

This equipment is intended for domestic and other similar uses, such as:

- Kitchen areas, shops, offices and other work environments
- Rural homes, hotels, motels and other residential buildings
- B&Bs and guest houses
- Catering services and similar retailers.
- Do not place the machine near inflammable solvents such as alcohol or diluents.
- Do not install the machine in excessively damp and dusty places, exposed to direct sunlight, outdoors or near to heat sources.
Machine installation in these places could cause fires or electric shocks.
- The appliance is not suitable for use in open places.

Electric power supply

- Do not connect or disconnect the machine from the socket with wet hands.
- Insert the plug into the wall socket firmly.
- Do not damage, modify, stretch, bend or twist the power cable.
Do not place heavy objects on the power cable.
- Do not connect the machine to a socket to which other equipment is connected (extensions, 2 or 3 plug adaptors, etc.)
- Do not use the machine if the power cable is tied or knotted.
- If smoke, unusual smells or strange noises are found coming from the machine, disconnect it immediately from the socket and contact the local retailer or technical service assistance.
Use of the machine in these conditions could cause fires or electric shocks.
- Periodically disconnect the machine from the socket and clean the plug and socket with a dry cloth.
If the machine is connected in a place exposed to dust, smoke or high humidity, the dust accumulated on the plug will absorb humidity and this could alter the insulation and trigger a fire.
- Do not spray water on the device; this could cause electric shocks or fires.
- The appliance must not be installed where water jets can be generated.
- Use a damp cloth to clean the machine. Do not use inflammable solvents such as alcohol, benzene or diluents. If inflammable substances come in contact with the electrical components inside the machine, they can cause fires or electric shocks.
- Before cleaning the machine, switch it off and disconnect it from the socket. Not being switched off or accidental switching on during cleaning could cause injuries to persons or damages to the machine.
- The equipment must not be used by children under 8 years of age or by people with physical, sensory or mental health problems, or people who lack the experience or the necessary knowledge, unless under surveillance and not before they have received the relevant instructions on how to use the equipment safely and they understand the inherent dangers.
Cleaning and maintenance for which the user is responsible must not be performed by children unless they are older than 8 yrs and supervised by an adult.

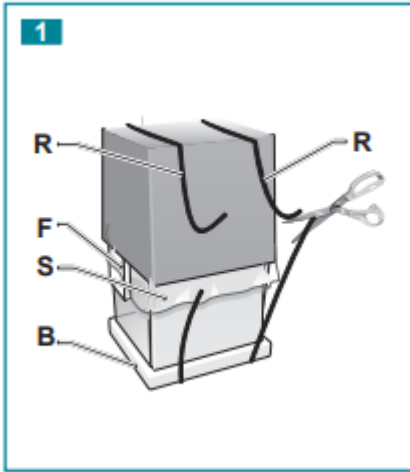

EN 2 REMOVAL OF PACKAGING

- Place the appliance in its installation site (chap. 5 - INSTALLATION).
- Cut straps **R** and remove carton **C**, polystyrene **F** and external plastic bag **S**.
- Do away with plastic bags **S** and polystyrene **F** immediately as they are a danger for children.
- Once the appliance is free from its packaging, remove the base **B**.

2.1 ADVICE ON HOW TO PROTECT THE ENVIRONMENT

Packaging

Packaging material is 100% recyclable.

For its disposal follow your local regulations.

The packaging material (plastic bags, polystyrene parts etc.) must be kept out of children's reach as it could be dangerous.

Information

This appliance does not contain CFCs (the cooling circuit contains a gas that is not harmful to the ozone layer).

For further details, please refer to the serial data plate on the appliance. **Produkt**

This appliance is marked according to the European directive 2012/19/EC on Waste Electrical and Electronic Equipment (WEEE). By ensuring this product is disposed of correctly, you will help prevent potential negative consequences for the environment and human health, which could otherwise be caused by inappropriate waste handling of this product.



The symbol on the product, or on the documents accompanying the product, indicates that this appliance may not be treated as household waste. Instead it shall be handed over to the applicable collection point for the recycling of electrical and electronic equipment.

Disposal must be carried out in accordance with local environmental regulations for waste disposal. For more detailed information about treatment, recovery and recycling of this product, please contact your local city office, your household waste disposal service or the shop where you purchased the product.

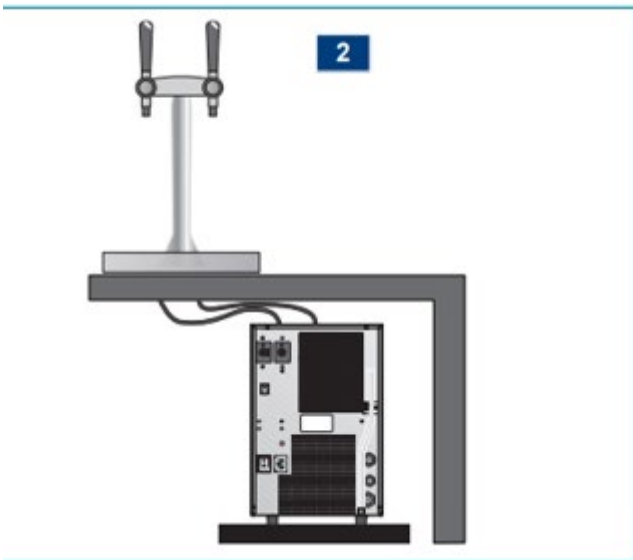

EN 3 DESCRIPTION OF THE APPLIANCE

These water coolers were designed to provide large quantities of still and carbonated cold water and water heated to 95°C.

They are easy to use and manufactured using top quality materials, offering the utmost hygiene and ease of maintenance; a UV safety system, available as an optional on countertop models. It protects the water distribution area from bacteria (patented system).

They should always be connected to a mains drinking water supply and can be fitted with special filtering kits.

They can be used in various settings, ranging from cafés, restaurants, offices and domestic environments; they should always be installed indoors and in the environmental conditions described under the "technical features" heading.

They are equipped with an internal cooling system, capable of supplying water cooled to $3 \pm 10^\circ\text{C}$.

They use a direct cooling system (Ice bank)

Two types of water coolers are available:

- Countertop (1)
- Undercounter (2)

Some models can also provide carbonated water (ACWG versions), in which case they need to be connected to a CO2 cylinder.

- The countertop models have, as standard, a solenoid valve with safety function (anti-flooding).

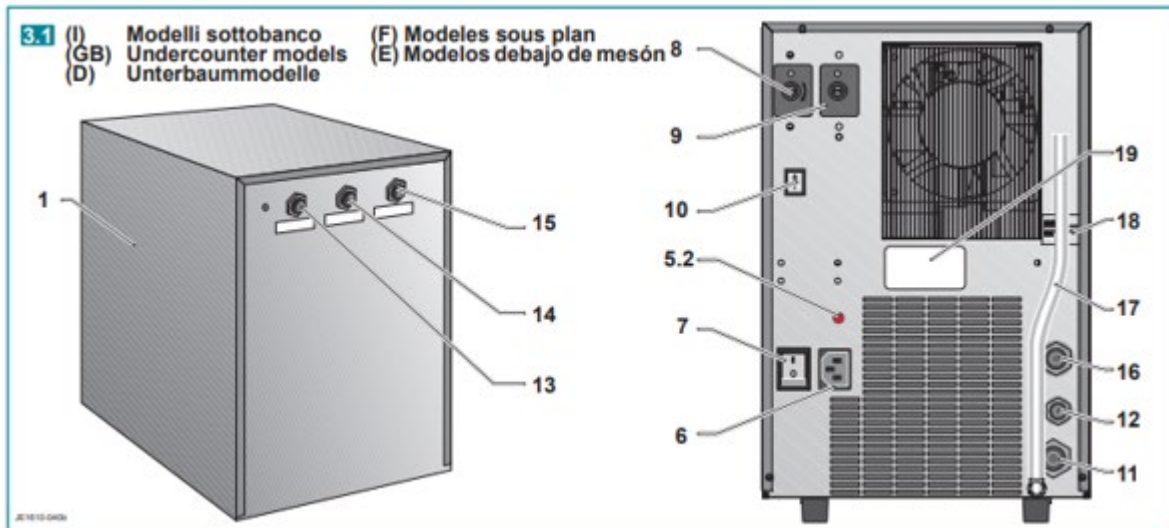

EN 3 DESCRIPTION OF THE APPLIANCE

- | | |
|---|---|
| <p>1 Casing: easily removable to reach interior parts</p> <p>2 Distribution spout: positioned in the protected area</p> <p>3 UV window</p> <p>4 Small tank to collect dripping water.
It is removable and can be connected to a drain</p> <p>5 Control panel</p> <p>5.1 Network voltage warning light</p> <p>5.2 Warning light for insufficient water
(only ACWG models)</p> <p>5.3 Cold water button</p> <p>5.4 Button for water at room temperature</p> <p>5.5 Sparkling water button (ACWG models)</p> <p>5.6 Hot water buttons (ACH models) must be pressed at the same time for distribution (SAFETY function)</p> <p>6 Electrical power supply socket</p> | <p>7 Main switch</p> <p>8 Cold water thermostat</p> <p>9 Hot water thermostat (ACH models)</p> <p>10 Hot water switch (ACH models)</p> <p>11 Mains water inlet: \varnothing 8mm or 3/4_M (TOP models)
\varnothing 8mm or 1/4_F (IN models)</p> <p>12 CO2 inlet \varnothing 6mm (ACWG models)</p> <p>13 Cold water outlet (\varnothing 6mm)</p> <p>14 Outlet for water at room temperature (\varnothing 6mm)</p> <p>15 Sparkling water outlet (\varnothing 6mm) – ACWG models
Hot water outlet – ACH models</p> <p>16 Water entrance for basin loading</p> <p>17 Level and basin unloading tube</p> <p>18 Basin water level indicator</p> <p>19 Data plates</p> |
|---|---|

EN 4 TECHNICAL CHARACTERISTICS

401110-000

Modelli sotto banco
Undercounter models
Untertisch-Gerät Modelle
Version sous plan
Modelos Bajo banco

Dimensioni
Dimensions
Abmessungen
Dimensions
Dimensiones
mm

A	400
B	255
H	405

HANDBOOK SECTION II

Reserved to qualified operators

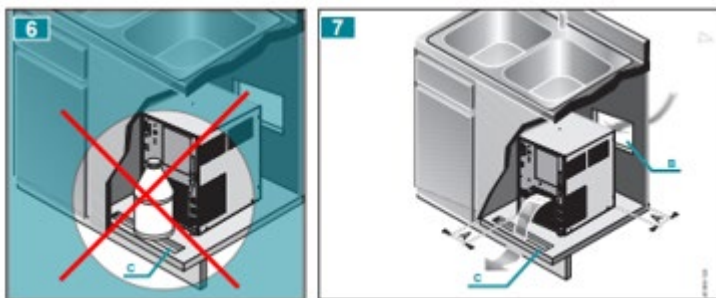
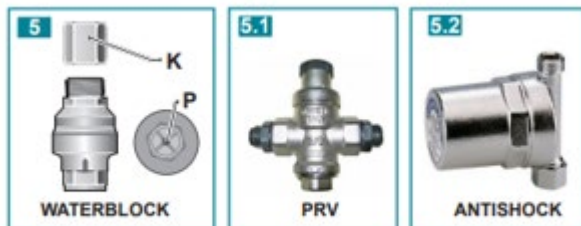

EN 5 INSTALLATION

5.1 POSITIONING THE APPLIANCE

Position the appliance in the point of installation, away from sources of heat and direct sunlight.

We also advise against installing the appliance outdoors and in very damp rooms.

- The appliance should be positioned in such a way as to leave approximately 6 + 7 cm of space (A) free for air to circulate freely. (fig.5-7)

Besides respecting the side space A for the air vent system, in the under-the-counter versions, place appropriate air grids/baffles in the housing of the device, in order to facilitate disposal of the heat produced by the refrigerating circuit (fig. 7).

- Install the machine under the sink, keeping the vent C completely clear. Do not put anything in the way that could prevent or restrict the circulation of air (fig.6)
- Make sure the water cooler is resting fully on all four supporting feet.
- C Air grids (Fig. 7) dimensions should be 370x150mm and 250x250mm for the B ones. These dimensions are recommended according to the environmental conditions and to the way of using the machine.

5.2 WATER CONNECTION TO THE MAINS

During connection of the appliance to the mains water supply, all pre-existing tubes, gaskets and joints placed between the appliance and the water mains connection must be replaced with new material to avoid contamination.

Before making the water connection, make sure the mains water pressure is between 2 and 3 bars.

- If the mains pressure is below 1 bar or the flow rate is less than 2 l/mim, fit a device capable of increasing the mains pressure (such as an autoclave or similar).



N.B.: the pressure is especially important for those water coolers fitted with a carbonation device.

- This water dispenser can be equipped with a WATER BLOCK anti-flooding device (optional) to prevent any accidental water leaks (fig.5). Once the WATER BLOCK device has intervened, fitting K should be disassembled and button P pressed to reset the device.
- If the mains water pressure exceeds 3 bars, predispose a pressure reducer capable of reducing the latter to the 2+3 range (fig.5.1).
- If instead of being connected directly to the aqueduct the machine is connected to an autoclave pump, then it is necessary to install above the water supply an ANTISHOCK device to prevent "water hammers" (fig. 5.2).

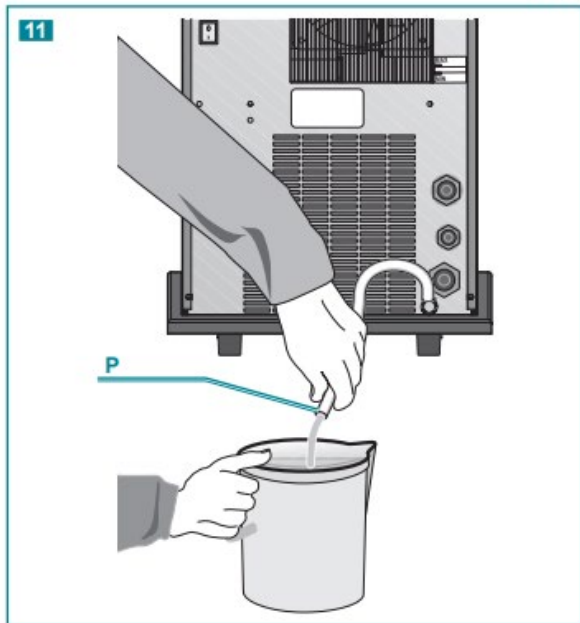
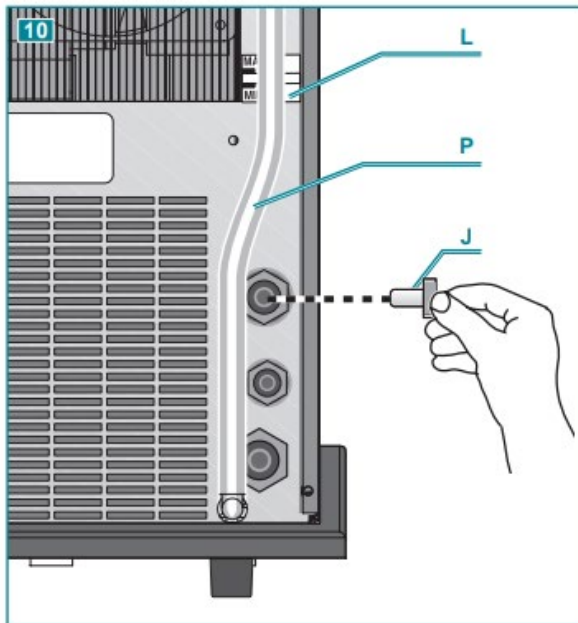
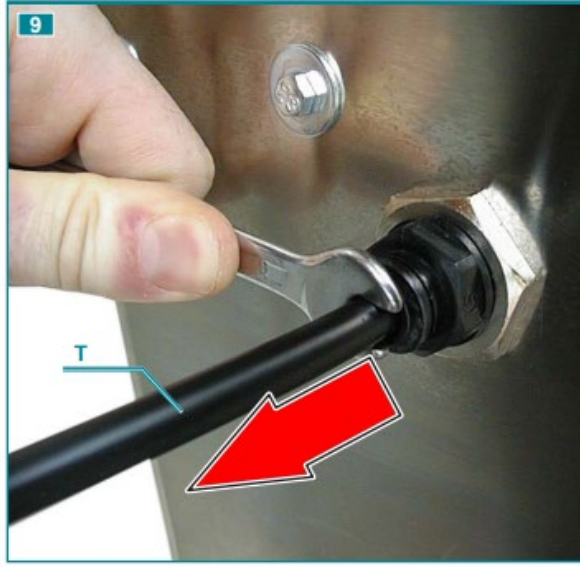
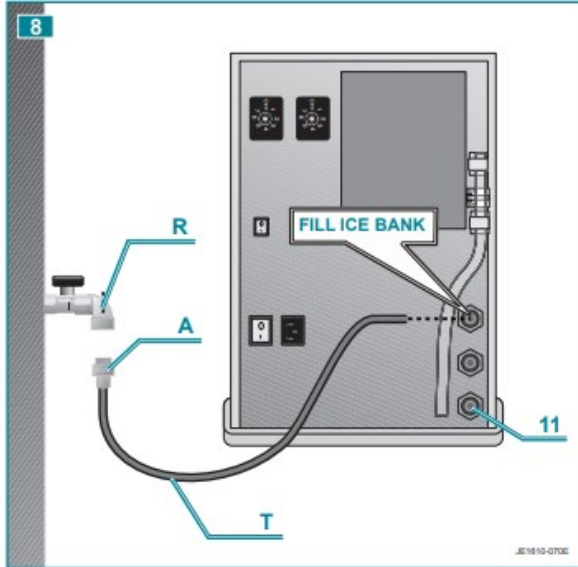

EN 5 INSTALLATION

Connection to the water mains is done using the T tube provided (8 mm diameter) and by terminal A (3/8M) for 8 mm pipe. The end piece A (3/8") should be connected to the water mains using a stop cock R. Connect pipe T to the stop cock, ensuring the OR seal is positioned correctly on coupling A (not supplied).

5.3 Ice container filling

Push tube T in the connection FILL ICE BANK with the necessary pressure. Open tap R and allow water to enter ice bank slowly until the water level in the vertical transparent (Fig. 10) pipe (P) reaches the position shown by plate "Fill". (L)

Close tap R.

Take off the tube T pushing with a 8 key on the locking ring and simultaneously pulling the tube (Fig. 9).

Insert immediately the red cap (J) on the connection FILL ICE BANK with the right pressure.

5.3.1 Water connection

Push pipe onto coupling 11 exerting the correct amount of pressure. For the water connection, you may also use the 1/4F metal fitting provided with the appliance and remove coupling 11.



The fitting on the water inlet is fitted with a mechanical filter.

5.3.2 Ice container emptying (for maintenance)

Disconnect the power supply cable from the outlet. To empty the ice tank after the ice melted, you just have to take the vertical level and tank discharge tube (P) off its site and let the water flow (fig. 11). After the ice container has been emptied (almost 4 litres), replace the tube in its place.

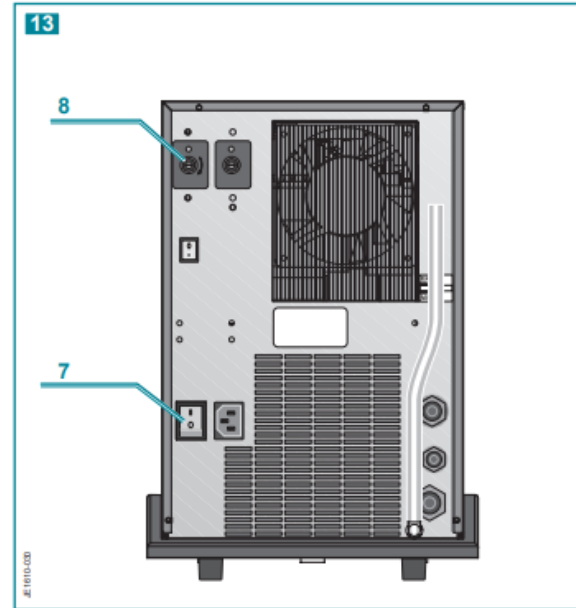
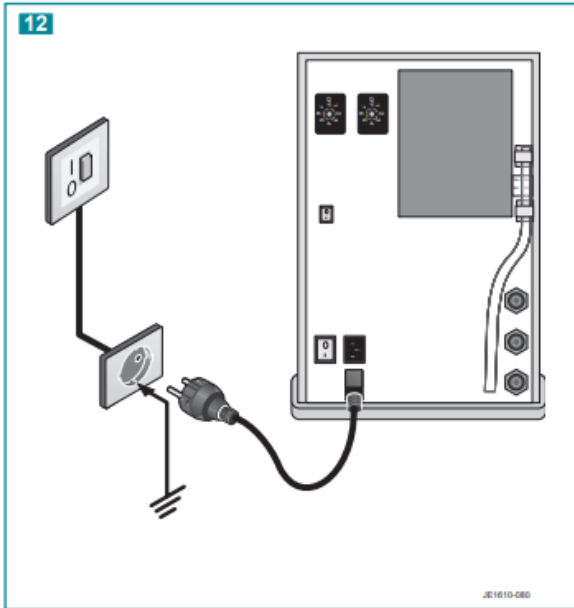

EN 5 INSTALLATION

5.4 ELECTRICITY CONNECTION

Connection to the mains electricity supply is carried out by connecting the plug to a mains socket.

The supply socket must be equipped with an efficient earth plate and it must be sized for the load of the appliance (see technical characteristics).

Make sure that the mains voltage corresponds with what is specified on the data plate. Make sure that there is an omnipolar switch above the socket with a minimum contact break of 3 mm protected by fuses of suitable amperage for the absorption of the appliance itself (see technical characteristics and data plate).



Connect the machine to a mains electrical network protected by a circuit breaker with a sensitivity equal to or less than 30 mA.

EN 6 STARTING

6.1 USE



Warning! Before using the machine proceed with the sanitation (see relative paragraph)
Warning! If the appliance has been laid down or turned upside down, you should wait at least 8 hours before starting it.

- Turn on the water tap and make sure there are no leaks.
- Turn on the main ON/OFF switch 7.
- Press the sparkling water button  until all the remaining air is eliminated from the circuit.
- Repeat the operation with the cold water  environment  button
- Adjust cold water thermostat 8 depending on use and season (positions recommended from 4 to 7)



The main switch 7 easily allows the disconnection of the device from the mains supply

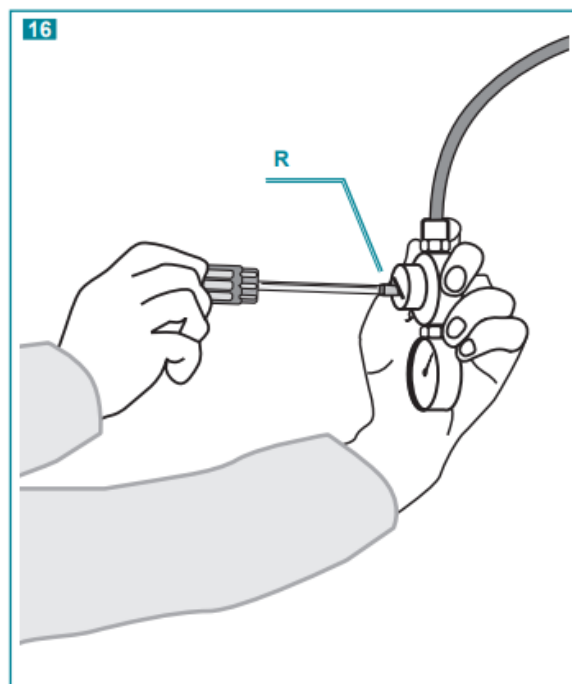
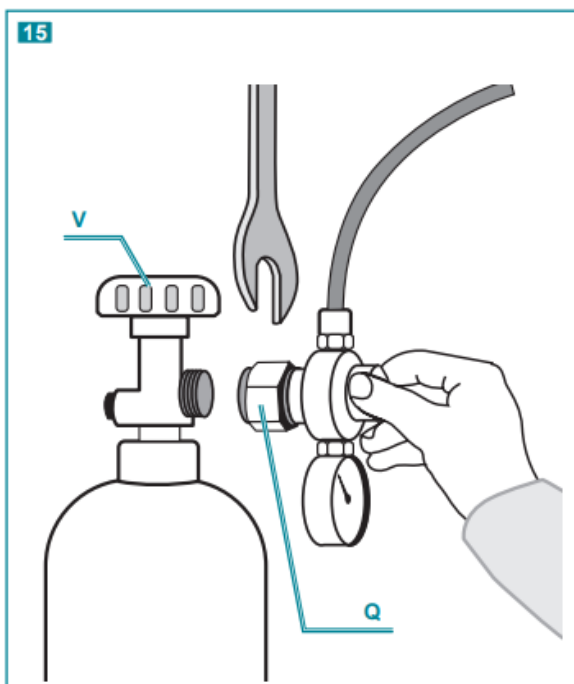
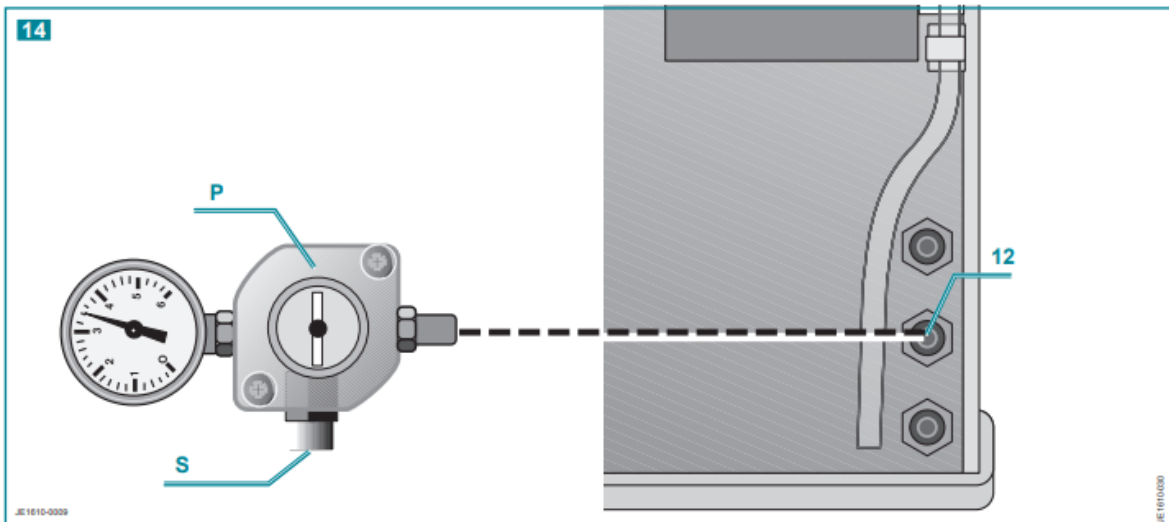

EN 7 SETTING UP THE SPARKLING WATER (ACWG models)

7.1 CO₂ GAS CYLINDER CONNECTION (CARBON DIOXIDE)

- The cylinder is positioned outside the appliance.
 - Connect the pressure reducer P to the fitting 12.
- With disposable cylinders (non-rechargeable), proceed as follows:
- Being careful of the gasket, screw the pressure reducer union S to cylinder attachment.

The cylinder is equipped with a sealing valve that will open when it is mounted onto the reducer valve and will close automatically when it is disconnected. The screw for regulating the reduction valve R has already been calibrated to the optimal pressure setting (approximately 3,5 bar). In any case, the quantity of gas supplied can be increased by turning the screw in the clockwise direction, or decreased by turning it in the anti-clockwise direction (fig.16). Disposable CO₂ cylinders with a capacity of 600 grams can charge approximately 120 liters of water.

- With rechargeable cylinders (B-RIC), proceed as follows:
- Paying special attention to the seal, screw the pipe union on the pressure reduction valve Q to the connector on the cylinder.
 - Open the valve on the cylinder V.
- The screw for regulating the reduction valve R has already been calibrated to the optimal pressure setting (approximately 3,5 bar). In any case, the quantity of gas supplied can be increased by turning the screw in the clockwise direction, or decreased by turning it in the anti-clockwise direction (fig.16). Rechargeable CO₂ cylinders can charge approximately 140 liters of water.

Caution! when using non-rechargeable gas cylinders, carefully follow the instructions contained on the label located on the cylinder itself.

NOTICE! Rechargeable cylinders are empty when supplied. Have the cylinder filled with gas by the nearest authorized distributor. Ask only for CO₂ (carbon dioxide) for "food products."

EN 7 SETTING UP THE SPARKLING WATER (ACWG models)

NOTICE

CAUTION! AFTER TRANSPORTING, STORING AND USING CO₂ CYLINDERS, FOLLOW LOCAL REGULATIONS CONCERNING THEIR USE.

- Press the pushbutton for carbonated water 
- Let a few litres of water flow until carbonated water begins to come out.

Attention!

The results of pressure variations on carbonation will only have effect when at least 2 litres of water have been drained off.

Advice on using the appliance for carbonated water

To guarantee the correct operation of the pump in time, the appliance must always be operated with water in the cooling circuit.

If mains water is insufficient, a protection system intervenes and blocks pump functioning (the NO WATER warning light is illuminated) To restore functioning the apparatus must be disconnected from the electrical network and reconnected when there is sufficient water in the mains system.

The quality of the carbonation process also depends on the temperature of the water, which means you should wait for the water cooler to have cooled the water down sufficiently upon installation and the ice bank has been formed.

Both still and carbonated water can be dispensed by pressing the relative buttons after approximately 40 minutes.



Attention!

Upon occurred installation, a correct flow of carbonated water takes about 35-40 seconds to distribute 1 litre.

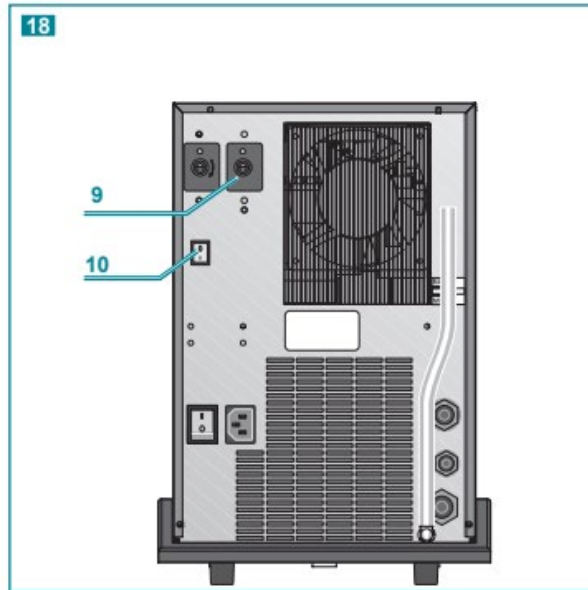
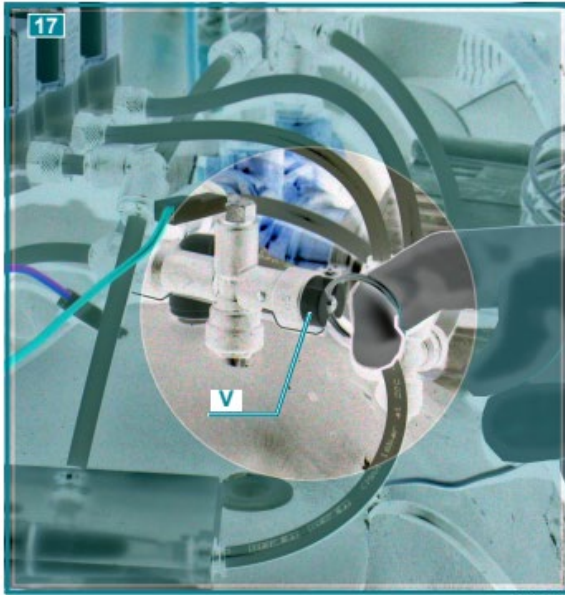

EN

Attention: to carry out this or any other maintenance operation requiring the machine casing to be opened, use protective gloves to avoid being cut by the sharp edges of the sheet steel

EN 7 SETTING UP THE SPARKLING WATER (ACWG models)

When installing the appliance, or if the water cooler has no water left inside it, a few air bubbles may enter the carbonation device.

These air bubbles could diminish the quality of the carbonation process, and we therefore recommend you remove them:

- Unscrew the cylinder from the reducer
- Remove the casing
- Drain the circuit by pulling the outlet valve ring V.
- Re-connect CO₂ cylinder to the reducer
- Drain off at least two litres of sparkling water
- Replace the casing

6.2 STARTING WITH HOT WATER (ACH MODELS)

These water coolers are fitted with a 1.0 litre stainless steel tank for the production and storage of water heated to 95°C max.

A special safety system allows for hot water to be dispensed only if both the  button and SAFETY buttons (red button on your left) are pressed simultaneously.

- Keep these buttons pressed at the same time to fill the tank with hot water, until a constant flow exits the dispenser.



This is extremely important and should be done before you turn switch 10 on, to avoid any permanent damage being caused to the hot water tank.

- Turn on switch 10.
- Set the desired temperature on thermostat 9; the temperature can be set from a minimum of 60°C to a maximum of 95°C.
- When switch 10 turns off, the water has reached the required temperature.



Warning!
Hot water at 95°C produces steam under pressure.

6.3 HYGIENIC CLEANING

- Once you have checked that the appliance operates correctly, proceed with the "internal cleaning and hygienic cleaning" phase as described in chap. 8.

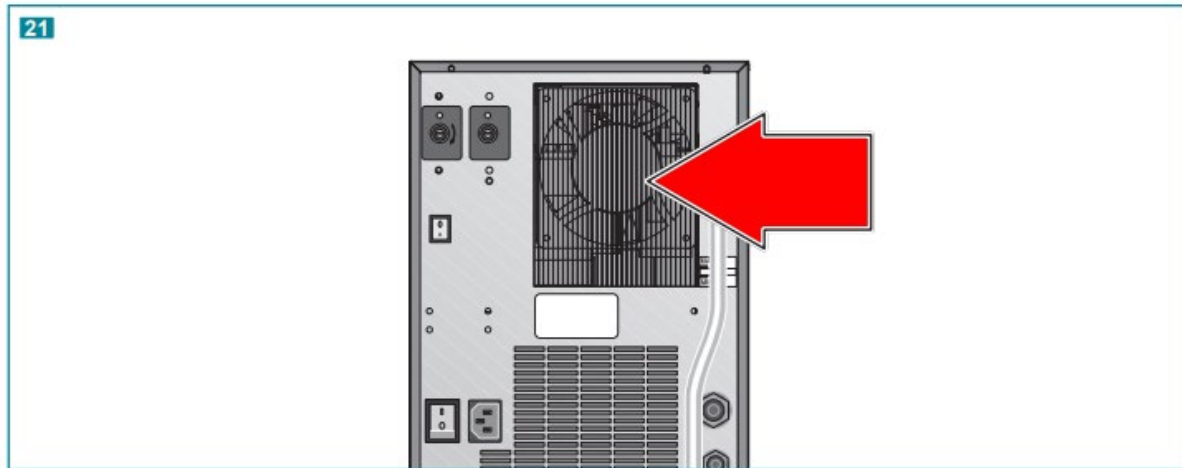

EN Maintenance operations should be carried out by a qualified professional. Be careful also not to damage the refrigerator system circuit.

EN 8 ROUTINE MAINTENANCE

Object	How	How often
Cleaning the mechanical water filter (fig.19-20)	• Disassemble the fitting on the water inlet and remove any impurities.	- Quarterly
Clening the outside of the appliance	• Clean the external part with a damp cloth, do not use solvents or abrasive detergents.	-
Replacing the CO ₂ cylinders	• Follow the instructions provided in paragraph 6.2	- When the manometer falls below 1 bar
PCleaning the water collection tray	• Clean the tray and remove any residue.	- Weekly
Cleaning the water dispensing spouts	• Remove the steel nozzle and eliminate all the limestone with a food descaling solution..	- Quarterly
Cleaning the cooling condenser (fig.21)	• Remove all dust and dirt with a domestic vacuum cleaner or similar appliance. • Do not use compressed air jets. • Do not use wire brushes	- Quarterly

EN 8 ROUTINE MAINTENANCE

Subject	How	How often
Check carbonation pump	<ul style="list-style-type: none"> Disconnect the pump from the electric motor and check the rotor turns freely. If it is stiff or blocked remove the scale inside the rotor using a de-scaling solution for food use 	- Six-monthly
Water replacement in the ice bank tank	<ul style="list-style-type: none"> Switch the apparatus off and wait about 1 hour for it to defrost Empty the water using the level and basin unloading tube P (see section 5.3.2) Restore the water level in the ice bank tank as described in the INSTALLATION chapter. 	- If the machine has been turned off for a long time.
Power lead	<ul style="list-style-type: none"> Check the condition and intactness of the power lead 	
CWater connection check	<ul style="list-style-type: none"> Check the condition and intactness of the water supply pipe. Check for any leaks 	

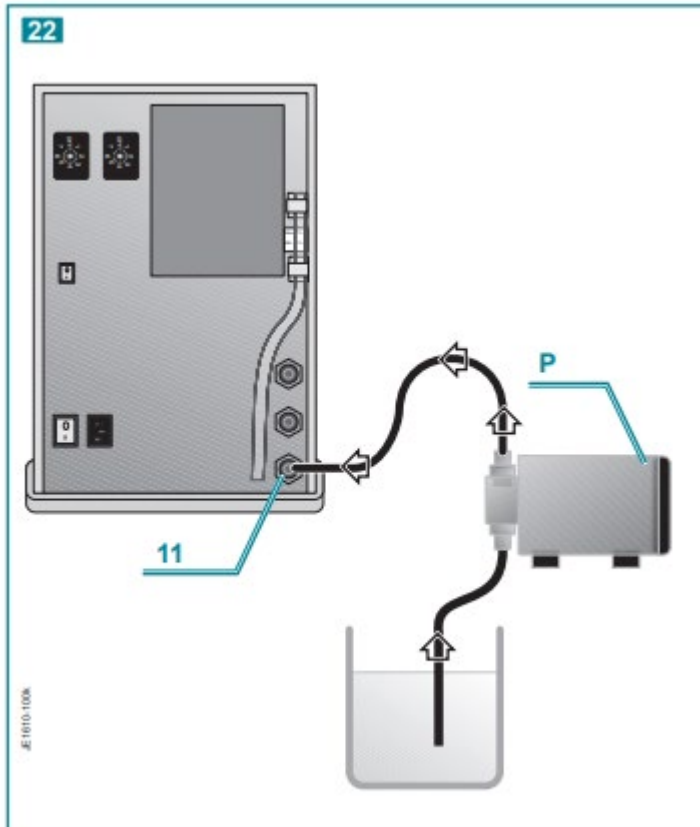

Warning: If a filtering kit is fitted on the appliance, it should be excluded from the hygienic cleaning process.

EN 8 ROUTINE MAINTENANCE

8.1 INTERNAL CLEANING/ HYGIENIC CLEANING (facultative for CU models)



WARNING! Considering that the products used for the hygienic cleaning are acid and alkali corrosive substances, disposable gloves must be used as well as glasses to protect your eyes. When this hygienic cleaning is carried out, you must keep to the product reaction times, percentages of hygienic detergent and quantity of water necessary for rinsing.

- The operation of higienization/sterilization has to be carried out every time the refrigerator is installed and:
 - every 6 months when it is used (*)
 - every time the water filter is changed
 - after an inoperative period of one or more weeks
- (*) If the refrigerator is installed in Hospitals, Schools, Old people's homes, or Clinics, it is recommended to sterilize it every 3 months

Hygienic cleaning solution preparation

- Prepare 5 litres of water
- Add to it 5% of "hydrogen peroxide" at 100 volumes; for the doses, use a graded measure or an ordinary syringe

NB: If you use commercial hygienic cleaning solutions, keep to the instructions provided by the manufacturer and included in the package.

- With the help of a pump P, connect the appliance's water inlet to the container with the disinfecting solution.

7.2 LIMESCALE REMOVAL (mod. ACH)

- Limescale should be removed from the hot water tank regularly, to avoid the build-up of limescale deposits. This should be done at least once a year or when you notice that hot water has some difficulty flowing out.

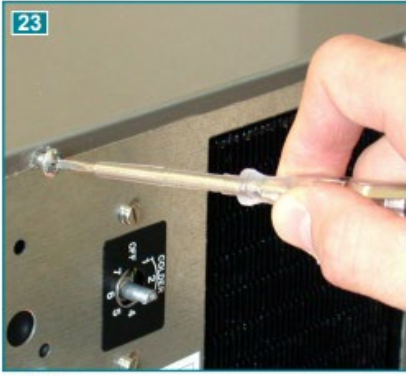

JE1610-0254



JE1610-0001



JE1610-0002

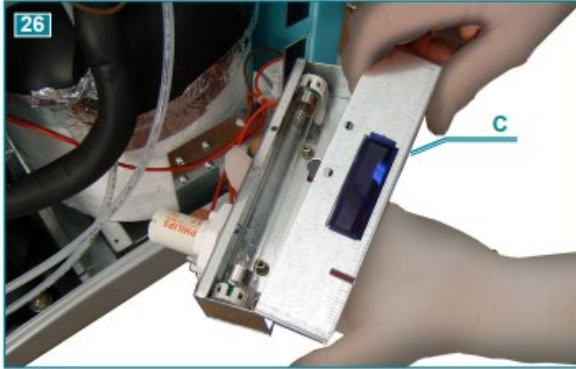

JE1610-0003

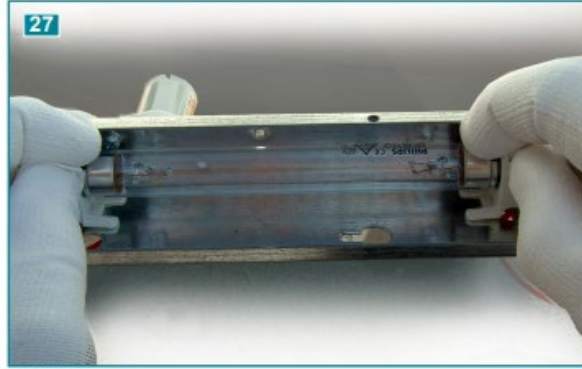

JE1610-0004

EN

Attention: to carry out this or any other maintenance operation requiring the machine casing to be opened, use protective gloves to avoid being cut by the sharp edges of the sheet steel

EN 8 ROUTINE MAINTENANCE

8.3 HOW TO REPLACE THE UV LAMP



The lamp must be replaced every 6000 hours of working (about 8 months)
This operation should be performed by a qualified technician.



Warning! direct irradiation of the UV lamp is dangerous both for the eyes and for the skin

• Wear protection latex disposable gloves to avoid touching the lamp with your hands. The contact with the skin can prejudice the duration of the lamp

How to replace the lamp:

- Remove the external casing (fig. 23) by removing the rear screws.
- Unscrew the two screw fasteners on the box (fig. 24)
- Remove the UV box from its support (fig. 25)
- Unscrew the tightening screw and remove the cover C (fig.26)
- remove the lamp and replace it with one of the same kind (fig.27)
- mount again all the components in reverse

EN 9 FAULTS AND REMEDIES



Warning! The operations should be carried out by a qualified professional.

9.1 DIAGNOSIS AND OPERATING ANOMALIES

This section includes the typical anomalies that could occur.

Many of these problems are not caused by the cooler, but they could be brought about by the electricity supply or by an incorrect use of the water cooler.

In the **ANOMALY** column, the problems reported by the customer are listed.

In the **POSSIBLE CAUSES** column, the "probable reasons" behind the problem are listed.

In the **INTERVENTION** column, the corresponding corrective action is listed.

COOLING SYSTEM

ANOMALY	POSSIBLE CAUSE	INTERVENTION
the compressor will not start	- power failure	- check that there is voltage in the plug
	- thermostat on the off position, or set to the minimum	- adjust the thermostat position
	- faulty thermostat	- replace the thermostat
	- the over-load protection of the compressor is faulty	- replace it
	- the starting relay is faulty	- replace it
	- the starting capacitor is faulty	- replace it
	- the compressor is faulty	- replace it
the water is cold but the appliance is operating excessively or non-stop	- little ventilation	- place the appliance away from the wall
	- the condenser is dirty or covered	- clean the condenser or free it of its obstacles
	- the thermostat is on maximum cold position	- adjust it
	- the room temperature is higher than 32°C	- it is normal that the appliance works at a continuously high room temperature
the compressor works continuously, but the water is not cold	- gas leak from the cooling system	- contact a specialised technician (refrigerationist)
	- the compressor is faulty	- replace the compressor
COOLING SYSTEM		
too much noise coming from the appliance, but it is working normally	- the machine is not levelled	- level the appliance using the adjustable feet
	- a few pipes are touching some parts inside the appliance, thus causing it to vibrate	- adjust the position of the pipes, making sure they do not touch any other parts
cold water comes out slowly or not at all	- low pressure of the inlet water	- take steps to increase the pressure (autoclave)
	- faulty solenoid valve	- replace it
	- clogged water filter	- replace it
	- the temperature adjuster is faulty and causes complete freezing of the ice compartment	- make the ice melt. replace the temperature adjuster
CARBONATING SYSTEM		
the carbonated water is not very fizzy or not at all	- the pressure of the gas in the co2 reducer is set to less than 3 bars	- increase up to 3.5 – 4 bars
	- co2 cylinder empty	- replace it
	- the temperature of the outlet water is high	- adjust the position of the thermostat to maximum
	- air bubbles inside the carbonator	- clean out the carbonator
only gas comes out of the carbonated water outlet	- the level probes are dirty	- control and replace
	- the pump turns continuously	- no water is entering or the water filter is blocked
	- the pump turns continuously, inlet water is present	- the pipe fitting into the carbonator is obstructed. disassemble and clean
	- the pump is blocked or the pump-motor is not working	- check it and replace it
	- the level controller is faulty	- control and replace
- the pump safety device has intervened (no water)	- check that there is pressure in the network disconnect and reconnect the machine from the electrical network to reset it	
continuous dripping from the outlets	- dirty solenoid valve	- disassemble the solenoid valve and clean it
the still water comes out carbonated	- there is a shortage of inlet water	- disassemble and clean or replace